

NM4 - NMS4

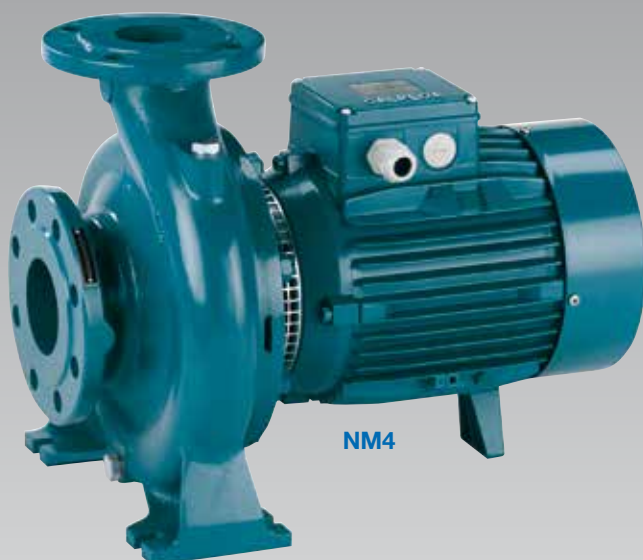

POMPES CENTRIFUGES MONOBLOCS À BRIDES 1450 TOURS / MINUTE



NM4

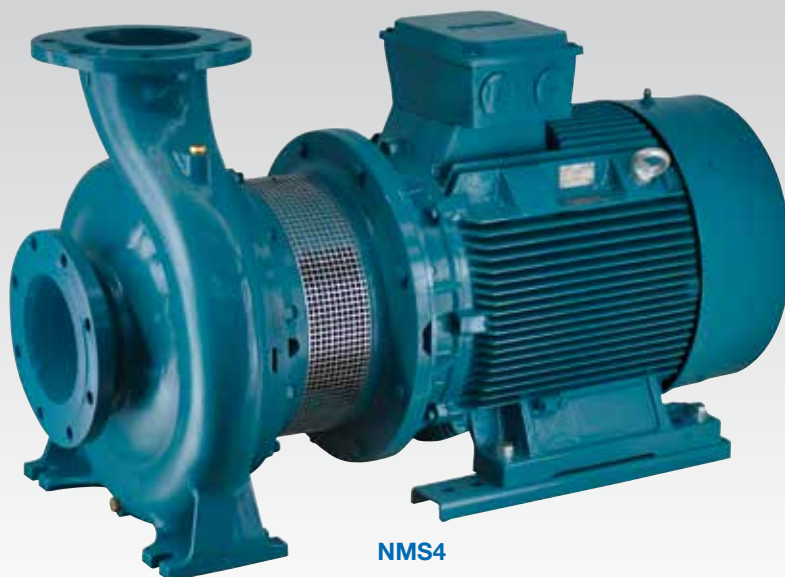

NMS4

NM4 - NMS4 Pompe centrifuge monobloc à brides 1450 tours/minute

Données techniques

Exécution

Electropompes centrifuges monobloc avec accouplement direct moteur-pompe et arbre unique jusqu'à 15 kW, exécution pour moteurs normalisés IEC avec palier butée intégré de 18,5 à 75 kW (*exécution stub-shaft*). Corps de la pompe à volute avec aspiration en bout et orifice de refoulement radial vers le haut, avec dimensions principales et performances selon EN 733 avec modèles ajoutés à complément.

NM(S)4 : Version avec corps de pompe et lanterne en fonte, en bronze (*pompes livrées complètement peintes*).

Orifices

Modèles : Orifices
NM4 25.. : Filetés ISO 228
de NM4 32/... à NMS4 150/... : Brides PN 10, EN 1092-2

Utilisations

- Pour liquides propres sans particules abrasives, non agressifs pour les matériaux de la pompe (*avec parties solides jusqu'à 0,2% max.*).
- Pour l'approvisionnement en eau.
- Pour les installations de chauffage, conditionnement, refroidissement.
- Pour applications civiles et industrielles.
- Lorsqu'il est demandé une marche silencieuse.
- Pour irrigation.

Limites d'utilisation

Température du liquide de : - 10°C à + 90°C.

Température ambiante jusqu'à : + 40° C.

Hauteur d'aspiration maxi : 7 m.

Pression finale maximum admissible dans le corps de la pompe : 10 bars.

Service continu.

Construction

Composant	Matériaux
Corps de pompe Lanterne de racc. NM4 Couvercle du corps NMS4 Lanterne de racc. NMS4	Fonte GJL-200 EN 1561
Turbine	Fonte GJL-200 EN 1561 Laiton P- Cu Zn 40 Pb 2 UNI 5705 Pour NM4 25/125 - 25/160 - 25/200 NM4 32/16 - 32/20 - 40/20
Arbre	Acier AISI 303 jusqu'à 1.1 kW Acier AISI 430 de 1.5 kW à 75 kW
Garniture mécanique	Carbone dur / Céramique / NBR
Contre-bridés	Acier Fe 430B UNI 7070

Moteur

Moteur à induction à 4 pôles, 50 Hz ($n = 1450 \text{ trs/min}$).

NM4, NMS4 : triphasé 230/400 V \pm 10% jusqu'à 3 kW;
400/690 V \pm 10% de 4 à 75 kW.

Isolation classe F. Protection IP 54 (*IP 55 pour NMS4*).

Classe haute efficacité IE3 pour moteur triphasé de 0,75 kW.

Exécution selon EN 60034-1; EN 60034-30.

Exécutions spéciales sur demande

- Autres voltages.
- Fréquence 60 Hz.
- Protection **IP 55**.
- Garniture mécanique spéciale.
- Pour liquide ou ambiance avec températures plus élevées ou plus basses.



NM4



NMS4

Plages d'utilisations

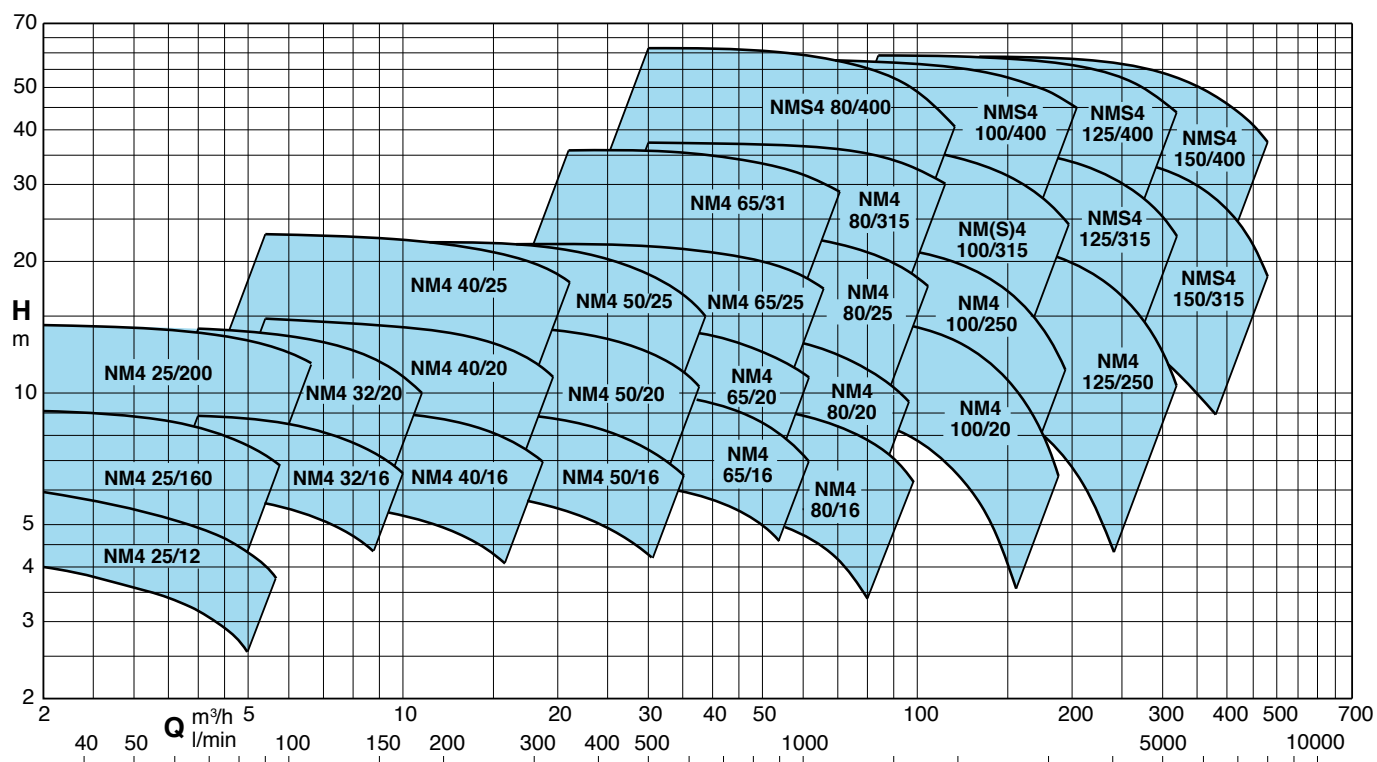

NM4 - NMS4 Pompe centrifuge monobloc à brides 1450 tours/minute

Performances n ≈ 1450 trs/min

Référence	MOTEUR		Asp. F	Ref. F	m³/h l/min	1	1.2	1.5	1.89	2.4	3	3.6	4.2	4.8	5.4	6	6.6	7.5	8.4	9.6	10.8	12	13.2			
	kW	A				16	20	25	31.5	40	50	60	70	80	90	100	110	125	140	160	180	200	220			
NM4 25-12A	0.25	0.8	1"1/2	1"	H m	6.1	6.05	6	5.9	5.8	5.5	5.2	4.8	4.4	3.9	3.3	-	-	-	-	-	-	-	-		
NM4 25-160B	0.37	0.95				7.7	7.65	7.6	7.55	7.5	7.2	6.9	6.6	6.1	5.5	4.6	3.6	-	-	-	-	-	-	-	-	-
NM4 25-160A	0.37	0.95				9.2	9.15	9.1	9.05	9	8.7	8.5	8.2	7.8	7.2	6.5	5.6	3.7	-	-	-	-	-	-	-	-
NM4 25-200C	0.37	0.95				11.5	11.4	11.4	11.3	11.2	11.1	10.9	10.7	10.5	10.2	9.9	9.5	8.7	7.8	6.2	4.1	-	-	-	-	-
NM4 25-200B	0.55	1.5				13.2	13.2	13.2	13.1	13.1	13	12.9	12.7	12.5	12.3	12	11.6	11.1	10.4	9.1	7.4	4.8	-	-	-	-
NM4 25-200A	0.75	1.9				14.5	14.5	14.5	14.5	14.5	14.4	14.3	14.2	14	13.8	13.6	13.3	12.8	12.2	11.2	9.7	7.5	4.1	-	-	-

Référence	MOTEUR		Asp. DN	Ref. DN	m³/h l/min	2.4	3	3.6	4.2	4.8	5.4	6	7.5	8.4	9.6	10.8	12	13.2		
	kW	A				40	50	60	70	80	90	100	125	140	160	180	200	220		
NM4 32-16B	0.37	0.95	50	32	H m	7.6	7.5	7.4	7.3	7.2	7.1	6.9	6.3	5.9	5.2	4.2	-	-		
NM4 32-16A	0.37	0.95				9	8.95	8.9	8.8	8.7	8.6	8.5	7.9	7.5	6.8	6	5.1	-	-	
NM4 32-20B	0.55	1.5				12.5	12.4	12.3	12.2	12	11.8	11.6	10.6	10	8.9	7.6	6.2	4.7	-	-
NM4 32-20A	0.75	1.9				14.3	14.2	14.1	14	13.9	13.7	13.5	12.9	12.3	11.3	10.2	8.9	7.5	-	-

Référence	MOTEUR		Asp. DN	Ref. DN	m³/h l/min	5.4	6	7.5	8.4	9.6	10.8	12	13.2	15	16.8	18.9	21	24	27	30				
	kW	A				90	100	125	140	160	180	200	220	250	280	315	350	400	450	500				
NM4 40-16C	0.37	0.95	65	40	H m	6.1	6	5.9	5.8	5.6	5.4	5.2	5	4.5	3.9	3.1	2.3	-	-	-				
NM4 40-16B	0.55	1.5				7.6	7.6	7.6	7.6	7.3	7.1	6.9	6.6	6.3	5.7	5	4	2.7	-	-	-			
NM4 40-16A	0.75	1.9				9.6	9.6	9.6	9.4	9.3	9.1	9	8.8	8.4	7.9	7.2	6.4	5.1	3.5	-	-	-		
NM4 40-20B	1.10	2.9				13	12.9	12.7	12.6	12.4	12.2	12	11.5	10.8	10	8.6	7	-	-	-	-	-		
NM4 40-20A	1.10	2.9				14.8	14.7	14.5	14.4	14.2	14	13.8	13.6	13	12.2	11.3	10	-	-	-	-	-		
NM4 40-25C	1.50	3.5				17.4	17.3	17.2	17	16.8	16.6	16.3	16	15.1	13.8	12.1	10.4	7.2	2.8	-	-	-	-	
NM4 40-25B	2.20	5				21.4	21.5	21.3	21.2	21	20.9	20.8	20.5	20	19.5	18.3	16.4	13.3	10	5	-	-	-	
NM4 40-25A	3.00	6.4				22.9	22.8	22.9	22.8	22.5	22.5	22.2	22	21.8	21.4	20.4	18.9	16	12.6	8	-	-	-	-

Référence	MOTEUR		Asp. DN	Ref. DN	m³/h l/min	10.8	12	13.2	15	16.8	18.9	21	24	27	30	33	37.8	42	48				
	kW	A				180	200	220	250	280	315	350	400	450	500	550	630	700	800				
NM4 50-16B	1.10	2.9	65	50	H m	8.2	8.2	8.2	8.1	8	7.8	7.6	7.2	6.7	6.2	5.5	4.4	3.3	-				
NM4 50-16A	1.10	2.9				9.6	9.6	9.6	9.5	9.5	9.3	9.1	8.8	8.3	7.8	7.2	6.1	4.9	3.1	-	-		
NM4 50-20C	1.10	2.9				11.8	11.8	11.7	11.7	11.5	11.3	10.9	10.4	9.8	9	8.1	6.3	4.7	-	-	-		
NM4 50-20B	1.50	3.5				13.4	13.4	13.4	13.3	13.1	12.9	12.6	12.1	11.5	10.8	9.9	8.2	6.4	3.7	-	-	-	
NM4 50-20A	2.20	5				14.9	14.9	14.9	14.9	14.8	14.6	14.4	14	13.4	12.8	12	10.4	8.6	6	-	-	-	
NM4 50-25D	2.20	5				14.5	14.4	14.3	14	13.7	13.4	13	12.2	11.2	9.7	8.1	5.4	2.3	-	-	-	-	
NM4 50-25C	2.20	5				17.8	17.8	17.7	17.5	17.2	16.8	16.4	15.7	14.9	13.8	12.4	9.7	6.8	-	-	-	-	
NM4 50-25B	3.00	6.4				20.7	20.7	20.7	20.6	20.4	20	19.5	18.9	18.2	17.1	15.9	13.2	10.6	5.8	-	-	-	
NM4 50-25A	4.00	8.3				22.7	22.7	22.6	22.5	22.4	22.1	21.6	21	20.2	19.4	18.3	16.4	13.6	9	-	-	-	-

Référence	MOTEUR		Asp. DN	Ref. DN	m³/h l/min	21	24	27	30	33	37.8	42	48	54	60	66	75	84			
	kW	A				350	400	450	500	550	630	700	800	900	1000	1100	1250	1400			
NM4 65-16C	1.10	2.9	80	65	H m	6	6	5.9	5.9	5.9	5.7	5.5	5.2	4.7	4	-	-	-			
NM4 65-16B	1.10	2.9				7.2	7.1	7.1	7	7	6.8	6.6	6.3	5.8	5.2	4.5	-	-	-	-	
NM4 65-16A	1.50	3.5				8.8	8.8	8.7	8.7	8.6	8.5	8.3	8	7.6	7.1	6.4	5.2	-	-	-	
NM4 65-16S	2.20	5				10.2	10.2	10.1	10.1	10	9.9	9.7	9.4	9.1	8.6	8	7	5.7	-	-	-
NM4 65-20B	2.20	5				11.9	11.8	11.7	11.6	11.4	11.1	10.8	10.2	9.5	8.7	7.8	6.2	4.3	-	-	-
NM4 65-20A	3.00	6.4				14.1	14	13.9	13.8	13.7	13.4	13.1	12.6	11.9	11.1	10.2	8.8	7.2	-	-	-
NM4 65-25B	4.00	8.3				18	17.9	17.8	17.7	17.6	17.3	16.9	16.3	15.4	14.4	13.1	10.8	8.5	-	-	-
NM4 65-25A	5.50	12.5				21.9	21.8	21.7	21.6	21.5	21.2	20.8	20.2	19.5	18.5	17.5	15.4	12.8	-	-	-
NM4 65-31C	5.50	12.5				25.8	25.7	25.5	25.3	25	24.4	23.8	22.8	21.5	20	18.2	15	11	-	-	-
NM4 65-31B	7.50	16				31	31	30.9	30.8	30.6	30.2	29.7	28.8	27.8	26.5	25	22.2	18.6	-	-	-
NM4 65-31A	9.20	19				35.9	35.9	35.8	35.7	35.5	35.1	34.6	33.8	32.8	31.6	30.2	27.8	25	-	-	-

NM4 - NMS4 Pompe centrifuge monobloc à brides 1450 tours/minute

Performances n ≈ 1450 trs/min

Référence	MOTEUR		Asp. DN	Ref. DN	m³/h l/min	30	33	42	54	60	66	75	84	96	108	120	132	150	168	180		
	kW	A				500	550	700	900	1000	1100	1250	1400	1600	1800	2000	2200	2500	2800	3000		
NM4 80-16C	1.10	2.9	100	80	H m	6.1	6.1	5.8	5.2	4.9	4.6	4	3.3	-	-	-	-	-	-	-		
NM4 80-16B	1.50	3.5				7.8	7.7	7.5	7	6.8	6.4	5.9	5.2	4.1	-	-	-	-	-	-	-	-
NM4 80-16A	2.20	5				10	10	9.8	9.5	9.3	9	8.5	8	7	5.9	-	-	-	-	-	-	-
NM4 80-20C	2.20	5				10.3	10.2	10	9.5	9.1	8.6	7.7	6.6	4.6	-	-	-	-	-	-	-	-
NM4 80-20B	3.00	6.4				12.1	12	11.8	11.4	11.1	10.6	9.8	9	7.5	5.7	-	-	-	-	-	-	-
NM4 80-20A	4.00	8.3				13.9	13.8	13.6	13.3	13	12.6	11.8	11	9.6	7.9	6	-	-	-	-	-	-
NM4 80-25C	4.00	8.3				16.9	16.8	16.6	15.9	15.4	14.8	13.9	12.7	11.1	9.3	7.2	-	-	-	-	-	-
NM4 80-25B	5.50	12.5				20.7	20.6	20.4	20	19.6	19.1	18.2	17.1	15.4	13.5	11.4	9	-	-	-	-	-
NM4 80-25A	7.50	16				23.7	23.7	23.5	23	22.7	22.2	21.5	20.5	19	17.2	15.1	12.7	-	-	-	-	-
NM4 80-31C	9.20	19				25.7	25.8	25.8	25.6	25.4	25	24.4	23.6	22.2	20.4	18.3	15.9	-	-	-	-	-
NM4 80-31B	11.00	22.5				30.3	30.5	30.7	30.7	30.5	30.2	29.6	28.8	27.5	25.9	24.1	22	-	-	-	-	-
NM4 80-31A	15.00	29				36.3	36.4	36.6	36.5	36.4	36.1	35.6	35	33.9	32.5	30.9	29	25.3	-	-	-	-
NMS4 80-315S	18.50	34.5				39.1	39.2	39.4	39.4	39.3	39.2	38.7	38.1	37.1	35.7	34.1	32.1	28.3	22.5	-	-	-
NMS4 80-400C	18.50	34.5				42.8	42.8	42.8	42.5	42.2	41.8	41	39.8	37.5	35.4	32.4	29.1	-	-	-	-	-
NMS4 80-400B	22.00	40.5	48.2	48.2	48.2	47.9	47.7	47.3	46.6	45.7	44.1	42.1	39.5	36.3	30.5	-	-	-	-			
NMS4 80-400A	30.00	55	61.4	61.5	61.6	61.5	61.3	61.1	60.7	60.1	59	57.6	55.8	53.7	49.5	-	-	-	-			
NMS4 80-400S	37.00	67	61.4	61.5	61.6	61.5	61.3	61.1	60.7	60.1	59	57.6	55.8	53.7	49.5	43.9	39.2	-	-			

Référence	MOTEUR		Asp. DN	Ref. DN	m³/h l/min	48	54	60	66	75	84	96	108	120	132	150	168	180	192	210		
	kW	A				800	900	1000	1100	1250	1400	1600	1800	2000	2200	2500	2800	3000	3200	3500		
NM4 100-20C	3.00	6.4	125	100	H m	9.4	9.3	9.2	9.1	8.9	8.5	8	7.3	6.5	5.6	4	-	-	-	-		
NM4 100-20B	4.00	8.3				12	11.9	11.8	11.7	11.5	11.2	10.7	10	9.3	8.4	6.7	4.5	-	-	-	-	-
NM4 100-20A	5.50	12.5				15.2	15.2	15.1	15	14.9	14.7	14.3	13.8	13.1	12.2	10.7	9	7.5	6	-	-	-
NM4 100-25B	7.50	16				19.5	19.5	19.4	19.3	19	18.7	18.2	17.5	16.6	15.6	13.8	11.7	10	8.4	5.5	-	-
NM4 100-25A	9.20	19				22.3	22.3	22.2	22.1	21.9	21.7	21.2	20.5	19.8	18.8	17.1	15	13.4	11.7	8.9	-	-
NM4 100-315C	11.00	22.5				26.9	26.9	26.8	26.6	26.2	25.7	24.9	23.8	22.7	21.3	18.9	15.9	13.7	11.3	-	-	-
NM4 100-315B	15.00	29				31.5	31.5	31.4	31.3	31.2	30.8	30.2	29.3	28.2	26.9	24.6	21.8	19.8	17.6	14	-	-
NMS4 100-315A	18.50	34.5				36.9	36.9	36.8	36.7	36.6	36.4	36	35.3	34.5	33.4	31.4	29	27.2	25.3	22.2	-	-
NMS4 100-400C	22.00	40.5				41.3	41.2	41.1	41	40.7	40.4	39.8	39	38	36.5	34	31	28.7	26	-	-	-
NMS4 100-400B	30.00	55				50.2	50.1	50	49.9	49.7	49.4	48.8	48	47.1	46	44	41.3	39.5	37	33.5	-	-
NMS4 100-400A	37.00	67				58.2	58.1	58	57.9	57.8	57.6	57.2	56.3	55.7	54.5	52.7	50.5	49	47	44	-	-

Référence	MOTEUR		Asp. DN	Ref. DN	m³/h l/min	84	96	108	120	132	150	168	180	192	210	240	270	300	330			
	kW	A				1400	1600	1800	2000	2200	2500	2800	3000	3200	3500	4000	4500	5000	5500			
NM4 125-25E	5.50	12.5	150	125	H m	11	10.8	10.5	10.1	9.7	9.1	8.3	7.8	7.2	6.2	4.4	-	-	-			
NM4 125-25D	7.50	16				14	13.9	13.7	13.4	13	12.4	11.6	11	10.4	9.4	7.4	5.1	-	-	-	-	
NM4 125-25C	9.20	19				16.7	16.6	16.4	16.2	15.9	15.4	14.6	14.1	13.5	12.5	10.4	8.2	5.8	-	-	-	
NM4 125-250B	11.00	22.5				19.3	19.2	19.1	18.9	18.7	18.2	17.5	17	16.3	15.3	13.3	10.9	8.2	-	-	-	
NM4 125-250A	15.00	29				22.7	22.7	22.6	22.4	22.2	21.8	21.2	20.8	20.1	19.3	17.4	15	12.4	9.3	-	-	-
NMS4 125-315C	18.50	34.5				27.9	27.8	27.7	27.6	27.2	26.5	25.6	24.9	24	22.8	20.2	17	13.5	9.5	-	-	-
NMS4 125-315B	22.00	40.5				31.8	31.7	31.6	31.5	31.1	30.6	29.7	29.1	28.5	27.3	24.9	22	18.5	14.3	-	-	-
NMS4 125-315A	30.00	55				36.8	36.8	36.7	36.6	36.4	35.9	35.2	34.7	34.2	33.2	31	28.4	25.3	21.6	-	-	-
NMS4 125-400C	37.00	67				45.4	45.3	45.2	45.1	44.9	44.4	43.7	43	42	40	37	33	28.5	23.5	-	-	-
NMS4 125-400B	45.00	81				51.4	51.3	51.2	51.1	50.9	50.4	49.7	49	48.2	46.8	44	40.5	36	31.5	-	-	-
NMS4 125-400A	55.00	96				59.2	59.1	59	58.9	58.7	58.2	57.7	57.2	56.7	55.7	53.5	50.5	46.5	42.5	-	-	-

Référence	MOTEUR		Asp. DN	Ref. DN	m³/h l/min	132	150	168	180	192	210	240	270	300	330	360	390	420	450	480		
	kW	A				2200	2500	2800	3000	3200	3500	4000	4500	5000	5500	6000	6500	7000	7500	8000		
NMS4 150-315D	18.50	34.5	200	150	H m	22.8	22.6	22.3	22	21.7	21.1	20	18.6	17	15.1	13	10.6	8	-	-		
NMS4 150-315C	22.00	40.5				25.6	25.4	25.1	24.9	24.7	24.2	23.3	22	20.4	18.5	16.5	14.1	11.6	8.9	-	-	-
NMS4 150-315B	30.00	55				30.6	30.6	30.5	30.3	30.1	29.7	29	27.9	26.5	24.9	23	20.8	18.3	15.4	-	-	-
NMS4 150-315A	37.00	67				35.6	35.6	35.5	35.4	35.3	35.2	34.6	33.7	32.5	31	29.2	27.1	24.7	21.8	18.5	-	-
NMS4 150-400C	45.00	81				45	44.9	44.7	44.5	44	43.5	42.5	40.5	38.5	36	33.5	30.5	27	23.5	19.5	-	-
NMS4 150-400B	55.00	96				50.8	50.7	50.5	50.3	50	49.5	48.5	47	45	43	40.5	38	35	32	28.5	-	-
NMS4 150-400A	75.00	130				58.8	58.7	58.6	58.5	58.3	57.9	57	55.5	54	52	49.5	47	44	41	37.5	-	-

Aspiration manométrique maximum : 1 à 2 mètres

Courbes hydrauliques $n \approx 1450$ trs/min

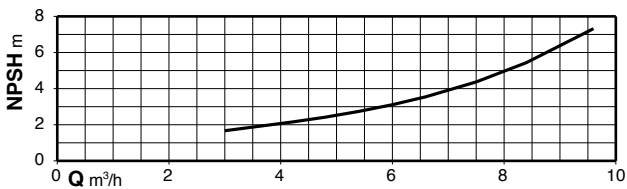
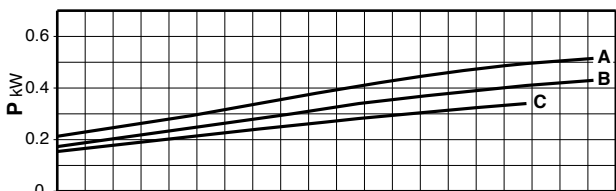
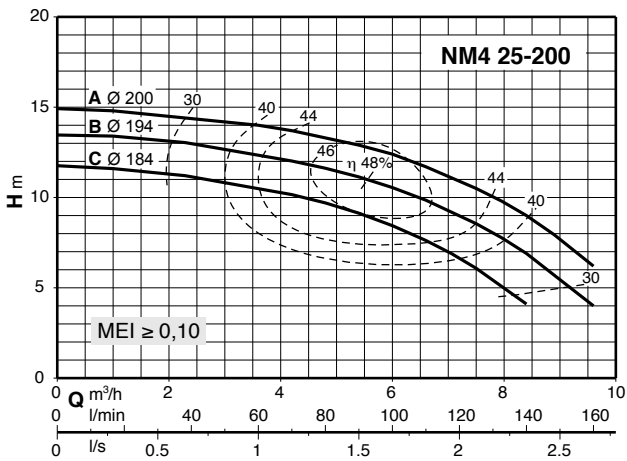
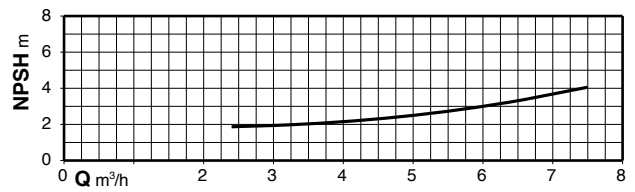
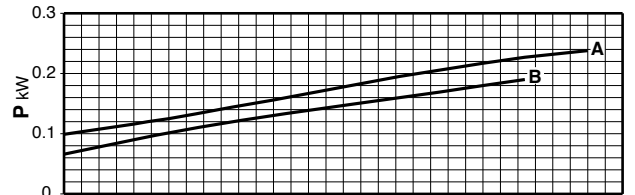
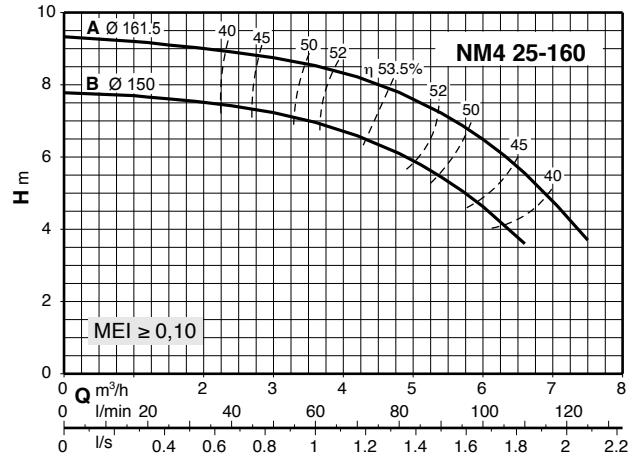
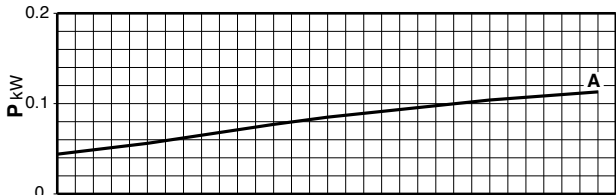
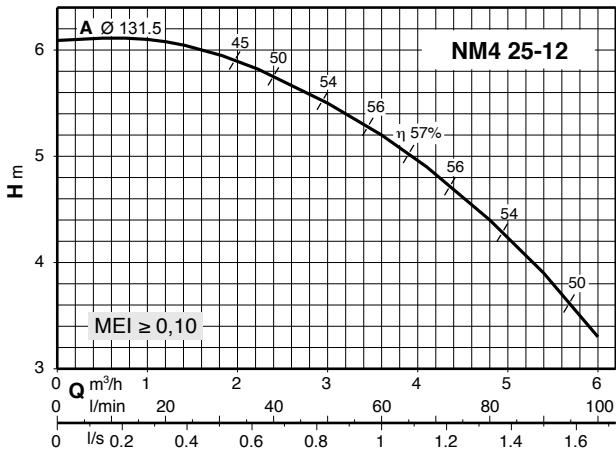

Courbes hydrauliques $n \approx 1450$ trs/min

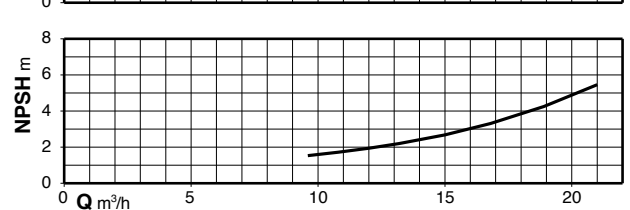
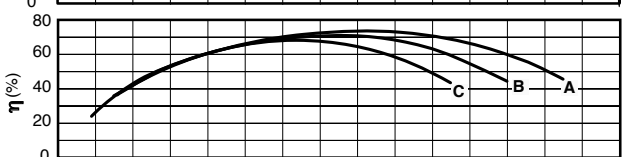
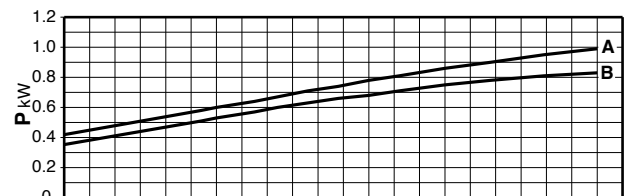
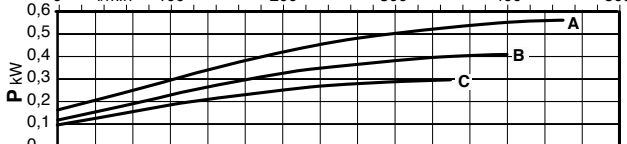
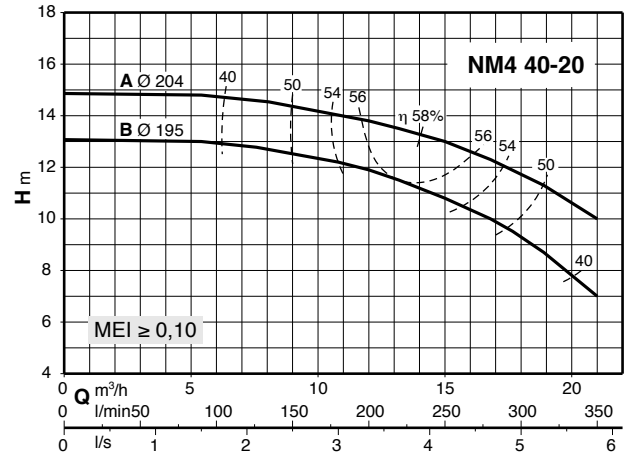
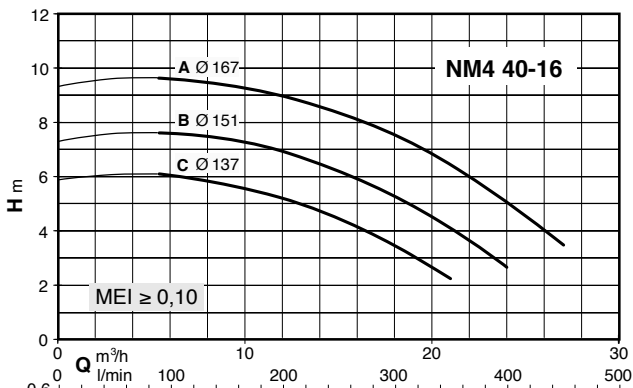
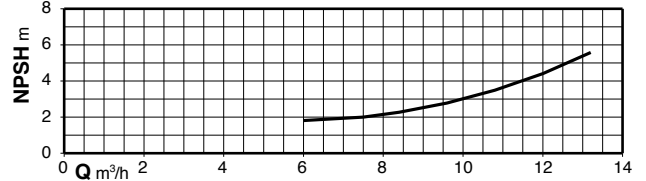
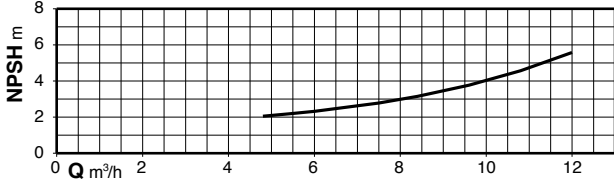
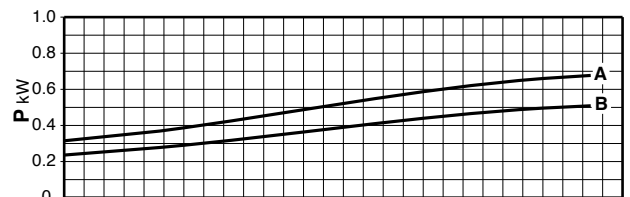
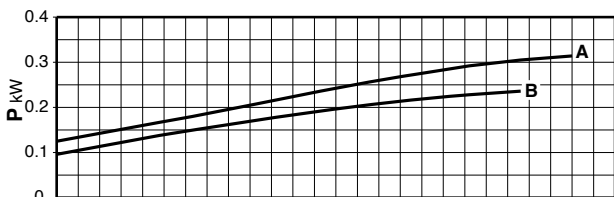
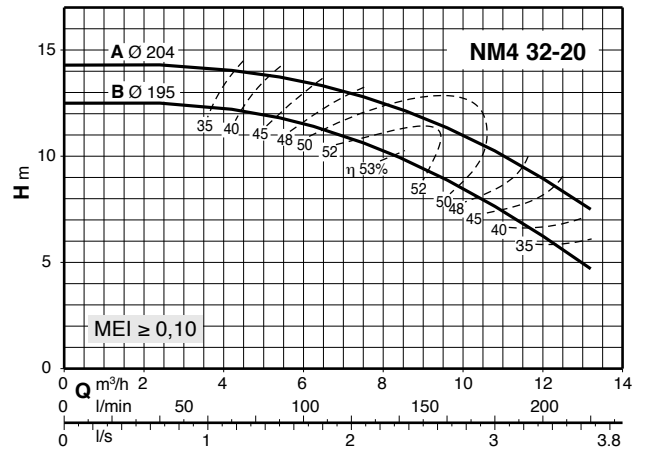
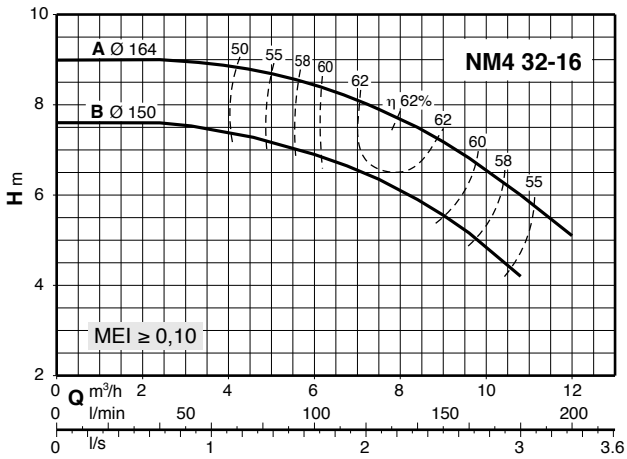

Courbes hydrauliques n ≈ 1450 trs/min

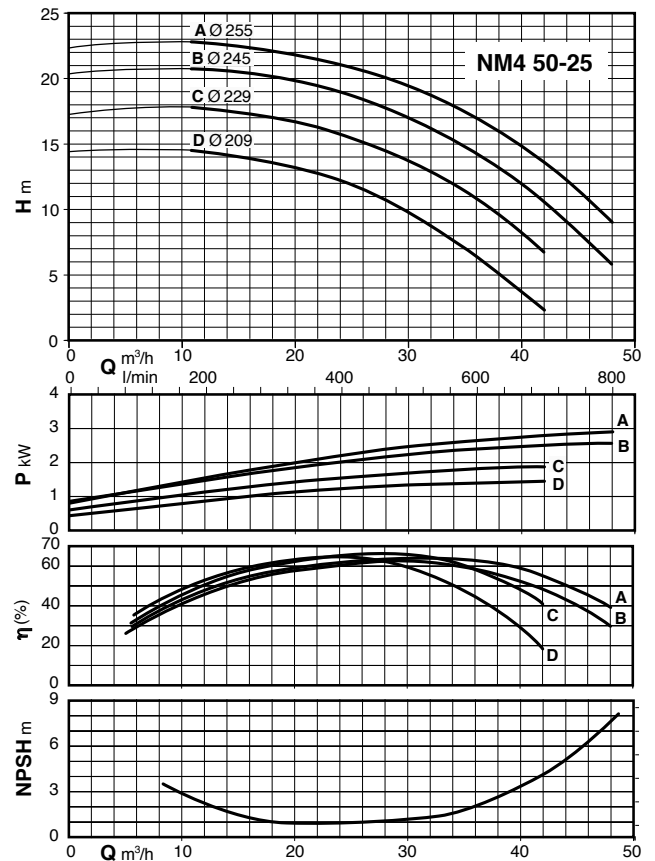
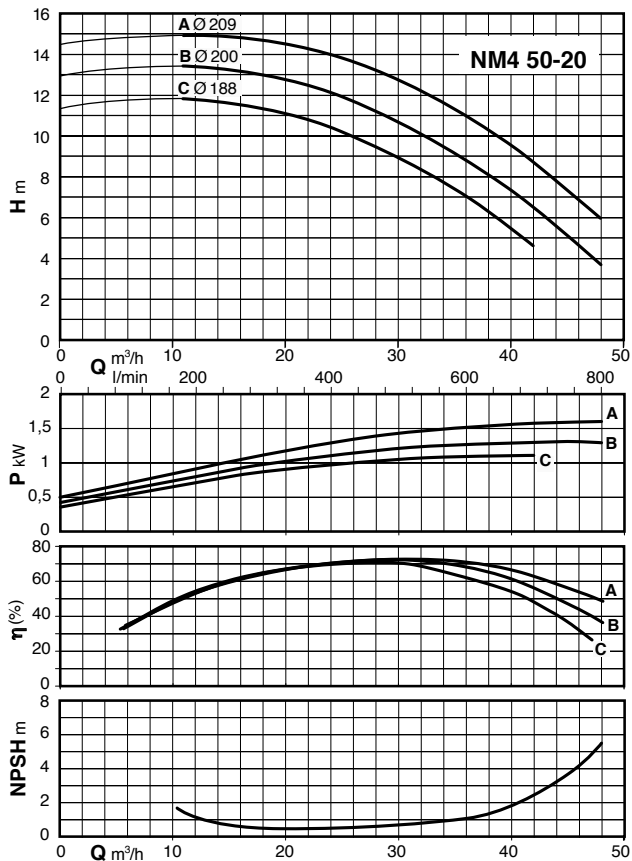
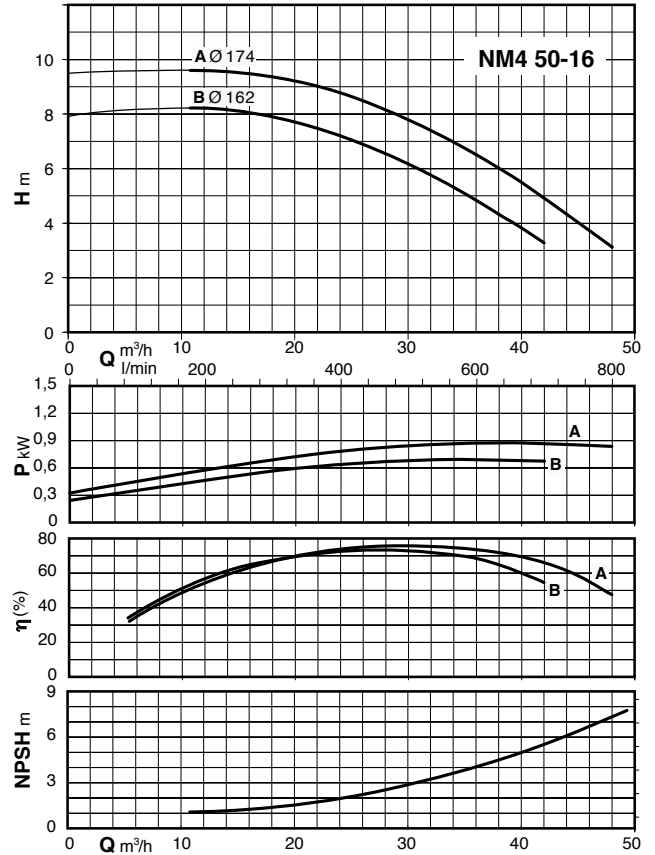
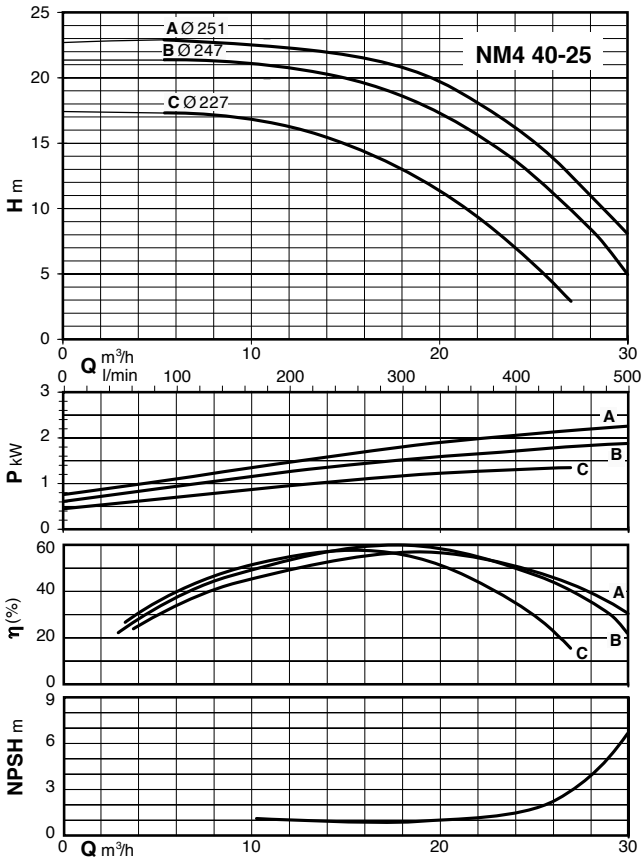

Courbes hydrauliques n ≈ 1450 trs/min

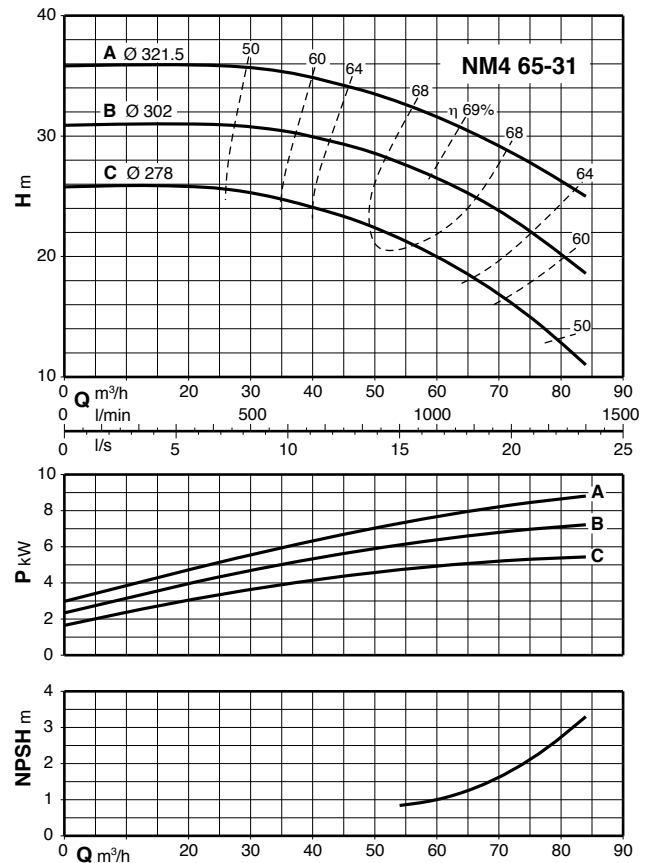
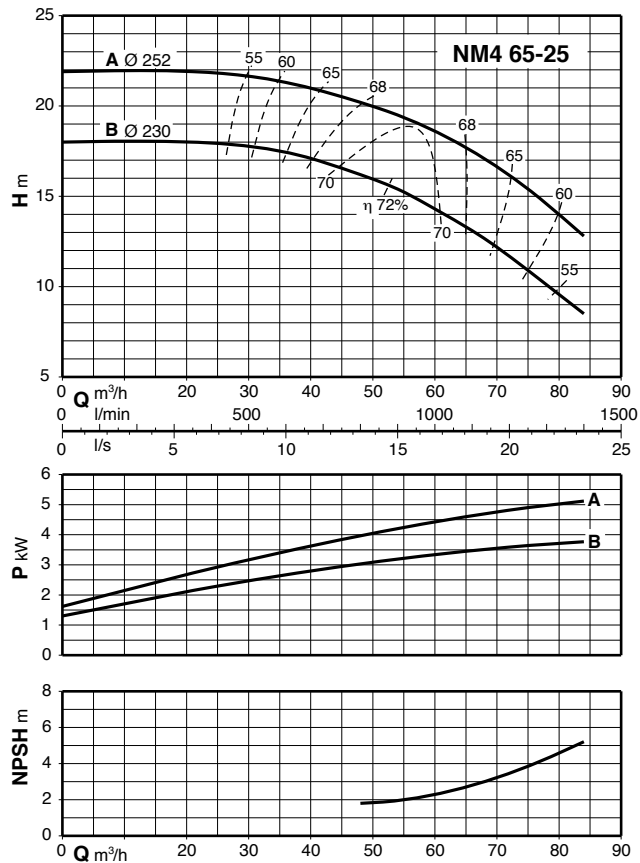
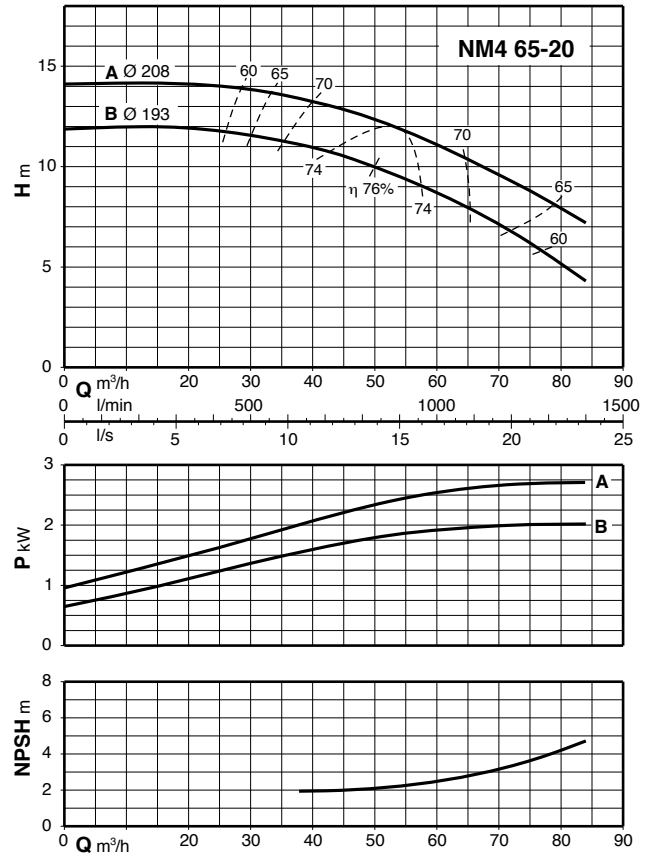
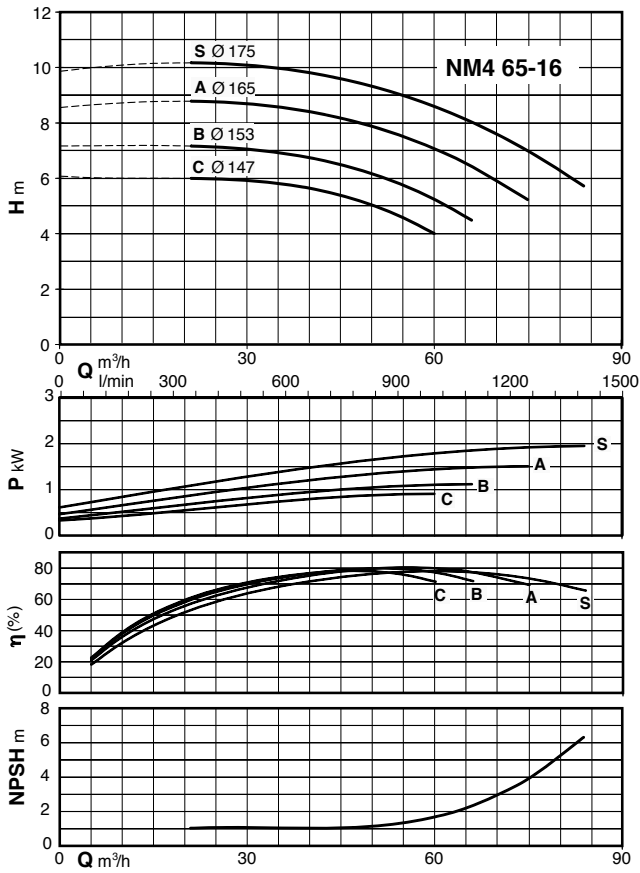

Courbes hydrauliques n ≈ 1450 trs/min

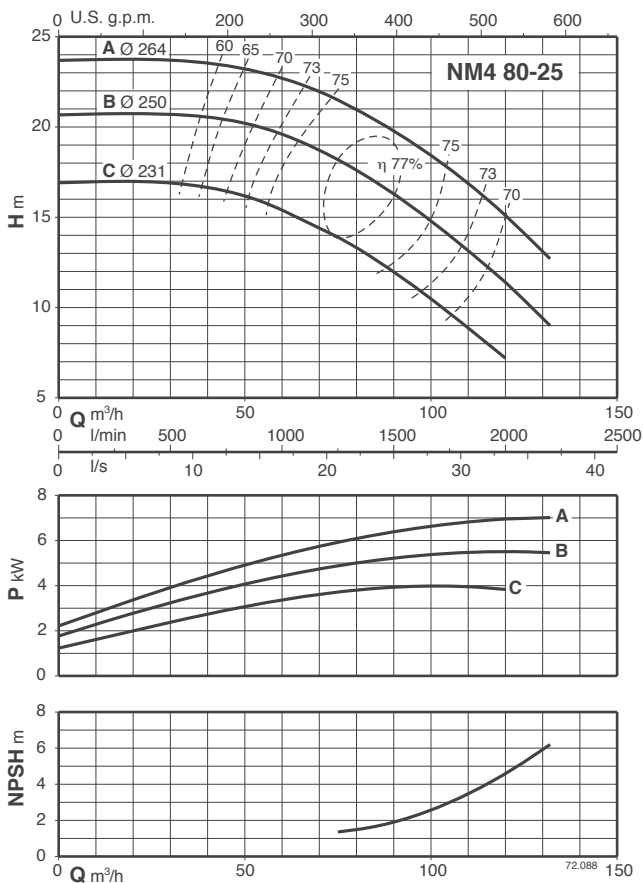
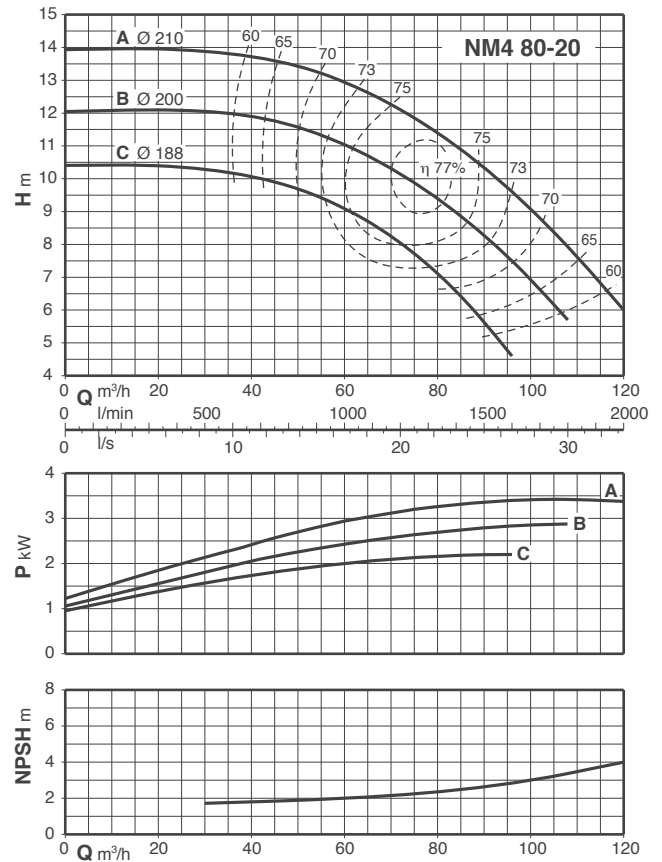
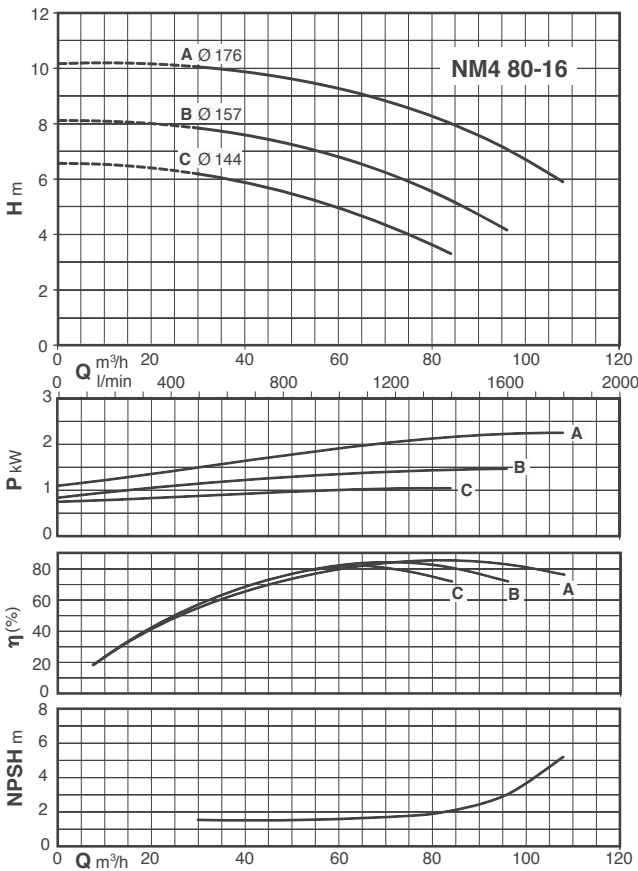

Courbes hydrauliques n ≈ 1450 trs/min

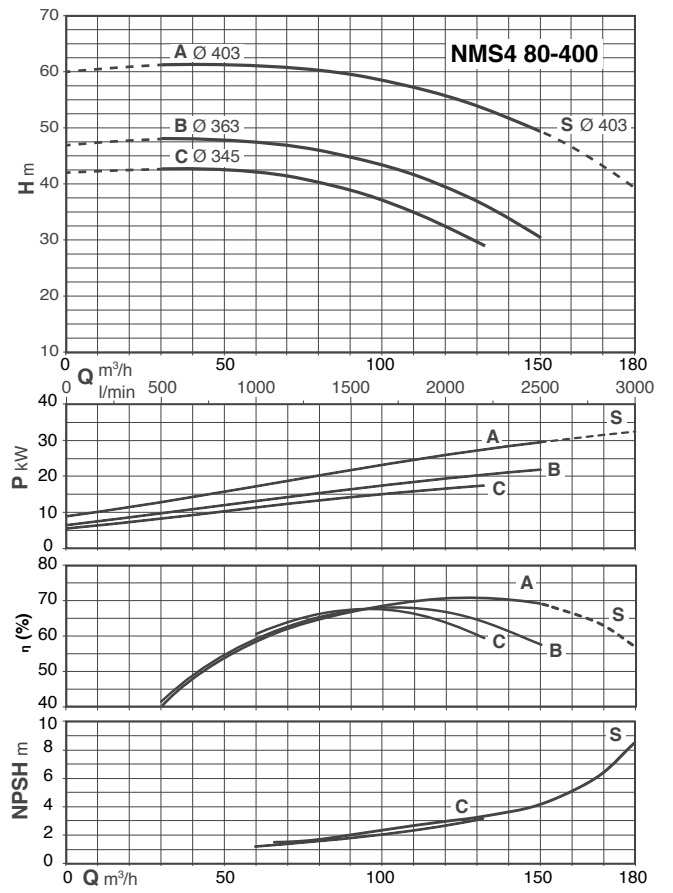
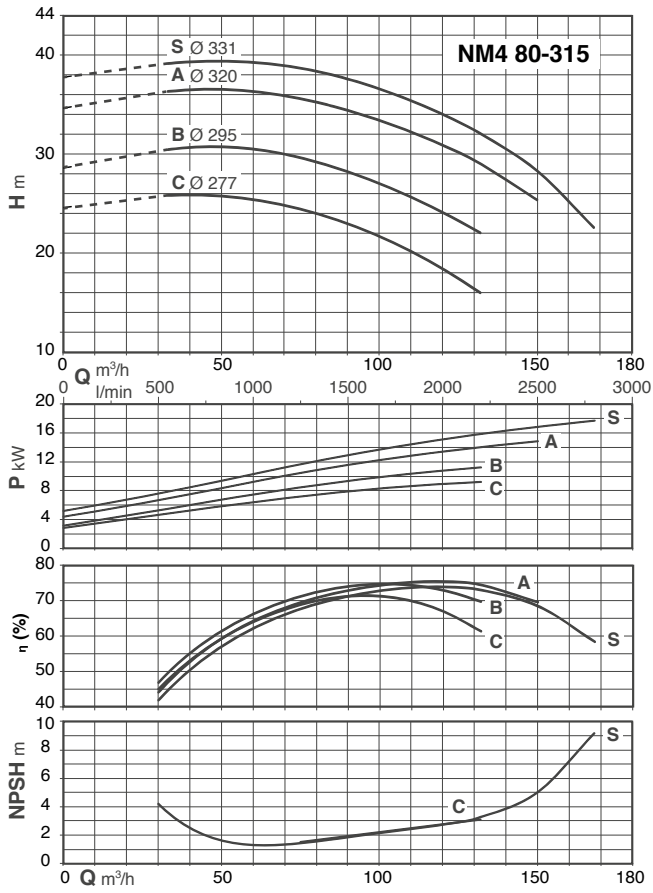

Courbes hydrauliques n ≈ 1450 trs/min

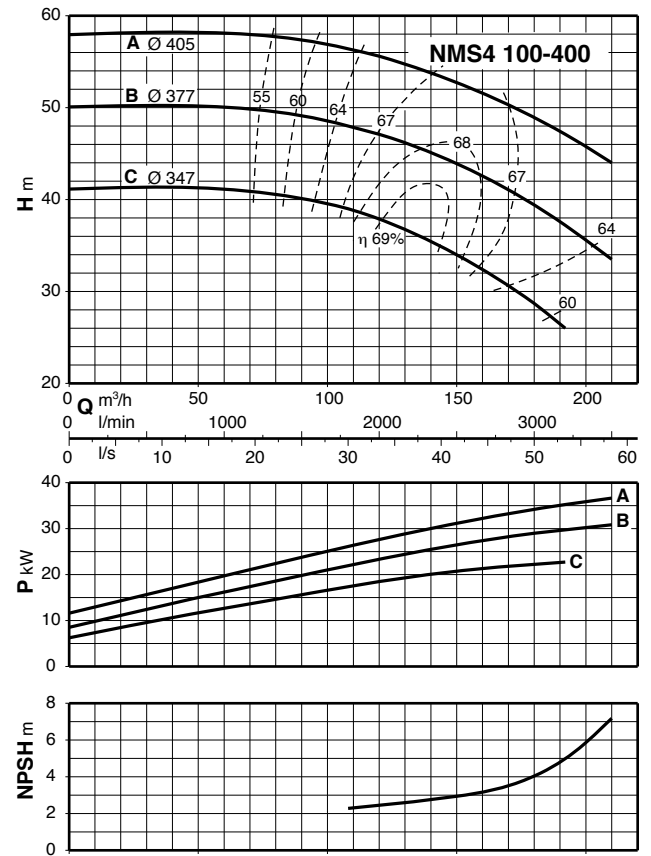
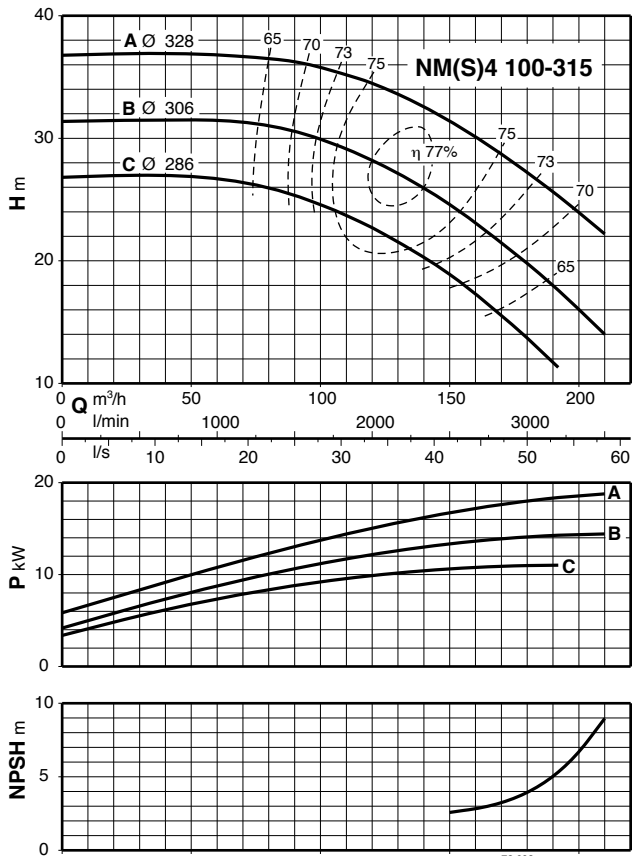
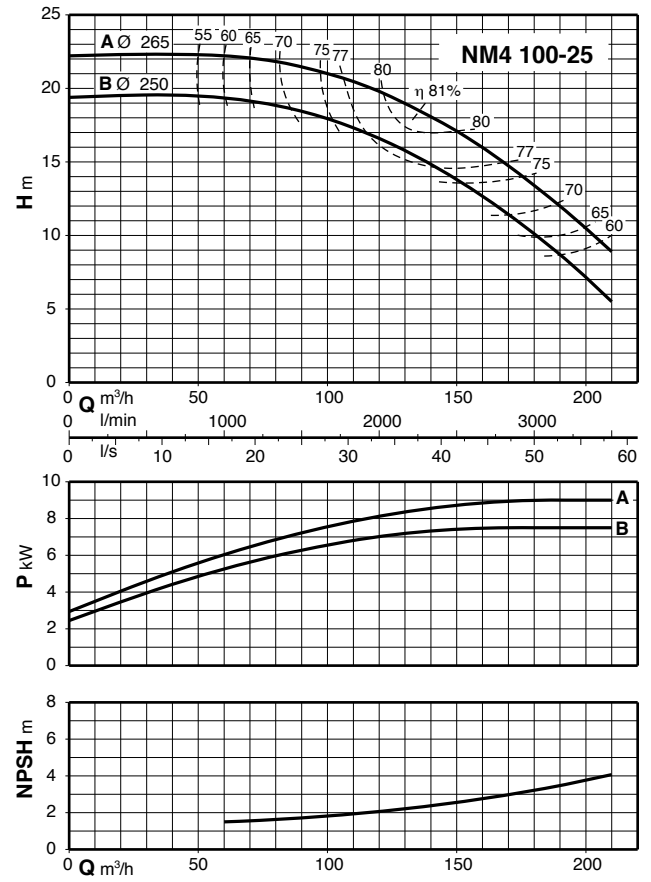
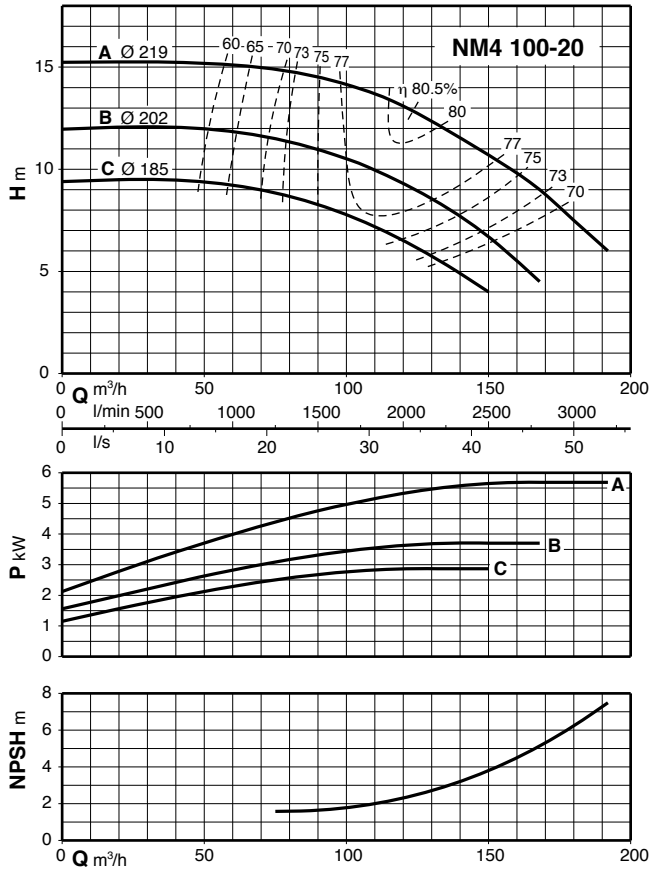

Courbes hydrauliques $n \approx 1450$ trs/min

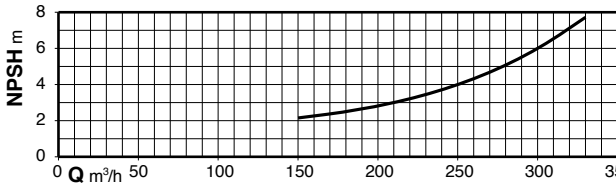
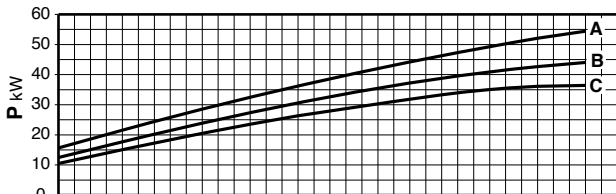
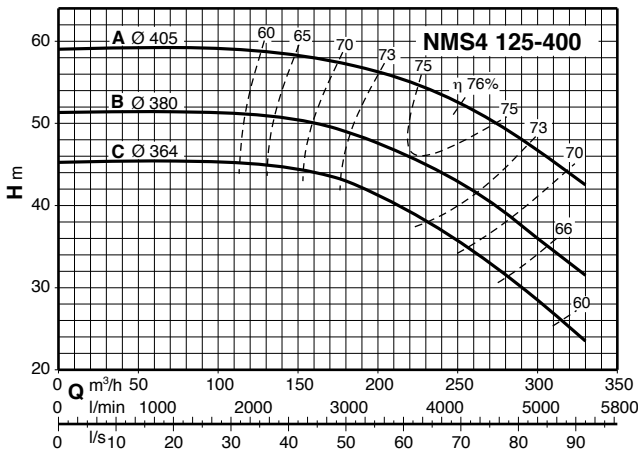
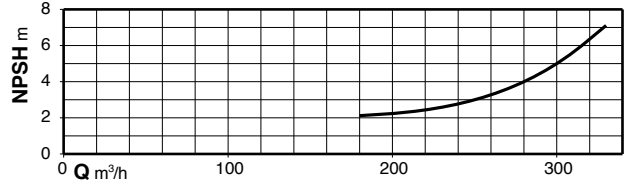
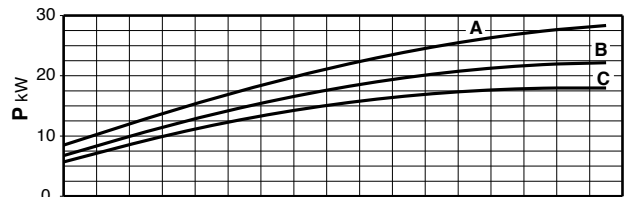
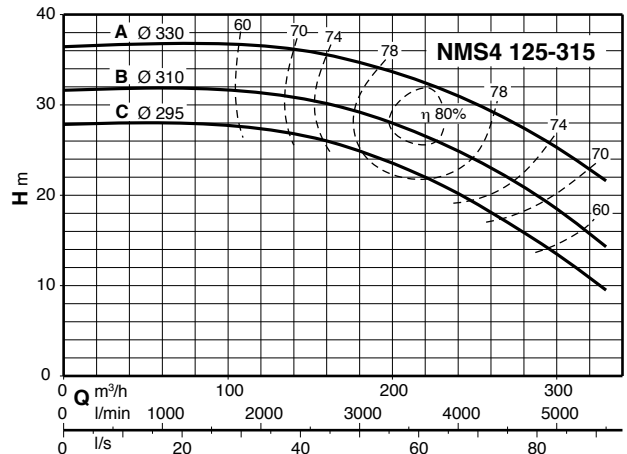
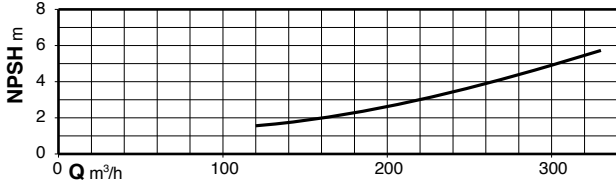
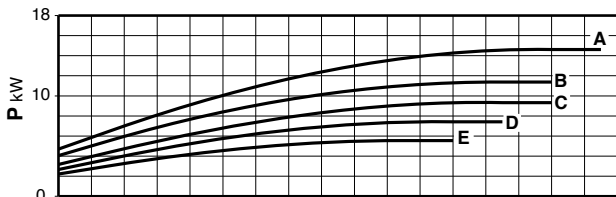
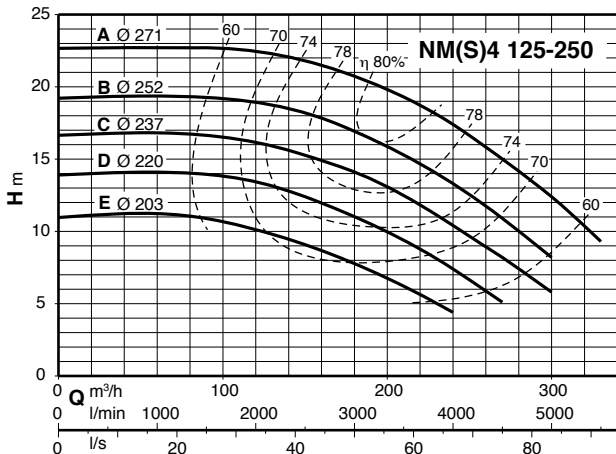

Courbes hydrauliques $n \approx 1450$ trs/min

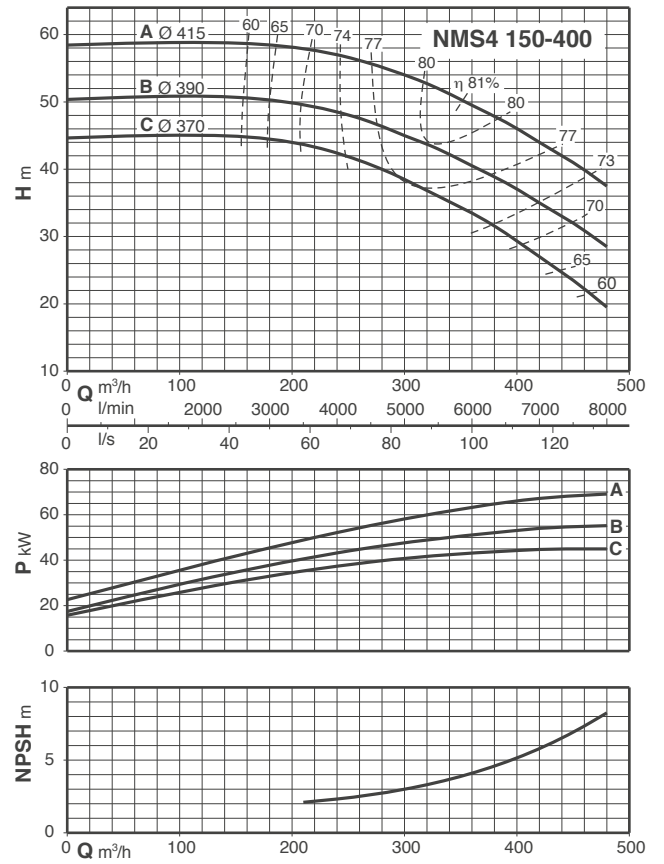
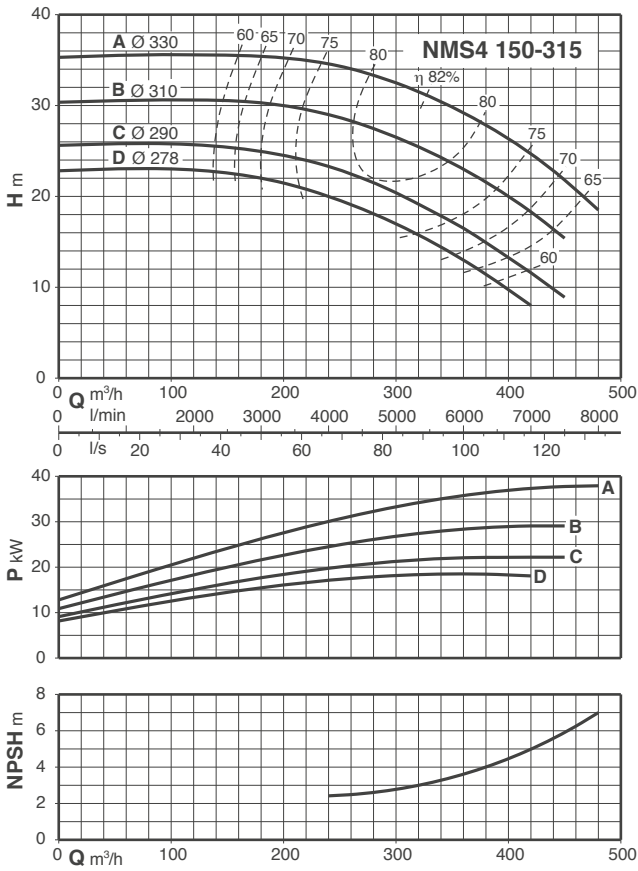

NM4 - NMS4 Pompe centrifuge monobloc à brides 1450 tours/minute

Dimensions et poids

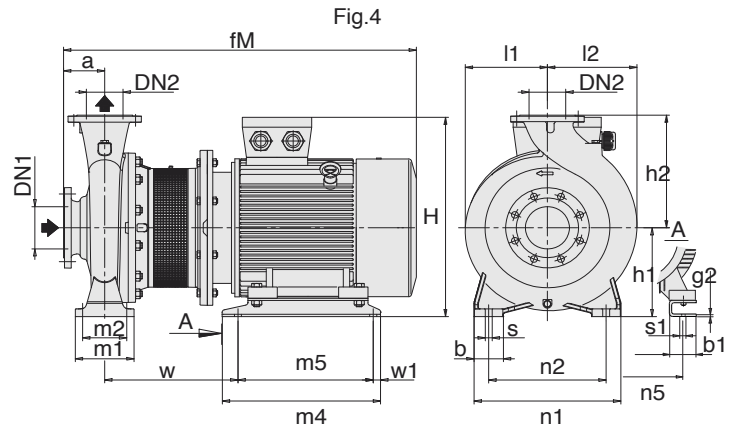
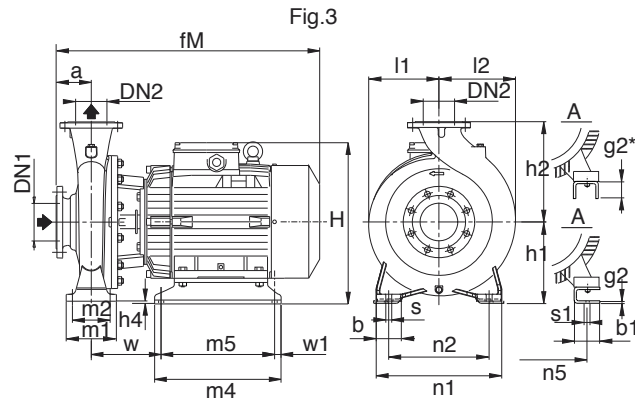
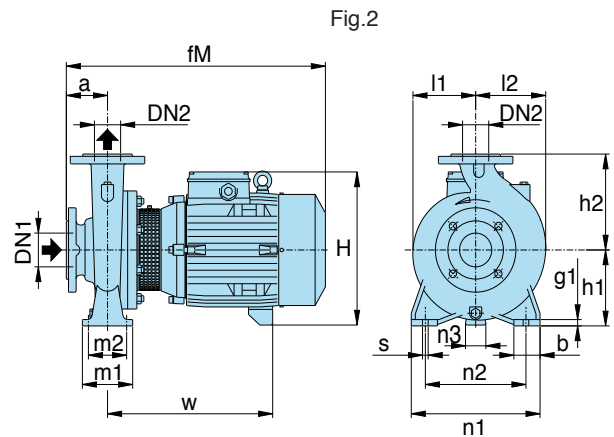
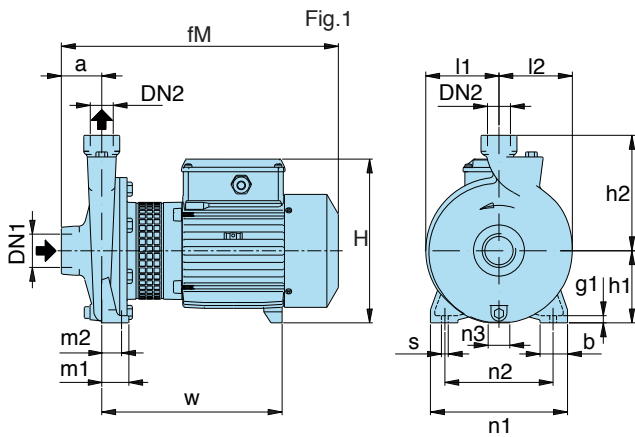

Brides EN 1092-2

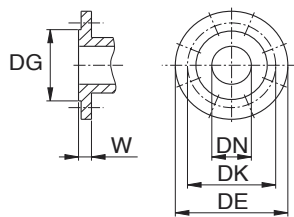

DN	DG	DK	DE	Trous		w
				N.	Ø	
32	76	100	140	4	19	18
40	84	110	150	4	19	18
50	99	125	165	4	19	20
65	118	145	185	4	19	20
80	132	160	200	8	19	22
100	156	180	220	8	19	24
125	184	210	250	8	19	24
150	211	240	285	8	23	26
200	266	295	340	8	23	30

NM4 - NMS4 Pompe centrifuge monobloc à brides 1450 tours/minute

Dimensions et poids

Référence	Fig.	ISO 228		Dimensions mm																Poids kg
		DN1	DN2	a	fM	h1	h2	H	m1	m2	n1	n2	n3	b	s	l1	l2	w	g	
NM4 25-12A	1	G 1"1/2	G1	56	313	90	140	199	37.5	27.5	170	130	9	38	9.5	85	88	250	10	13.5
NM4 25-160B					380	100	160	228	37.5	27.5	190	150	30	38	9.5	102	102	250	10	17.5
NM4 25-160A				63	385	125	180	253	45	32.5	245	200	49	45	11.5	125	125	250	11	21.5
NM4 25-200C																				23
NM4 25-200B																				27
NM4 25-200A																				

Référence	Fig.	ISO 228		Dimensions mm																Poids kg
		DN1	DN2	a	fM	h1	h2	H	m1	m2	n1	n2	n3	b	s	l1	l2	w	g1	
NM4 32-16B	2	50	32	80	410	132	160	260	100	70	240	190	47	50	14	120	120	255	12	30
NM4 32-16A						160	180	288					62			140	140			34.5
NM4 32-20B						62	175	175	300	330	38									
NM4 32-20A																				

Référence	Fig.	ISO 228		Dimensions mm																Poids kg				
		DN1	DN2	a	fM	h1	h2	H	m1	m2	n1	n2	n3	b	s	l1	l2	w	g1					
NM4 40-16C	2	65	40	80	410	132	160	268	100	70	240	190	47	50	14	119	119	255	12	31				
NM4 40-16B						160	180	288					62			140	140			37				
NM4 40-16A						65	40	100	470	160	180	288	100	70	265	212	62	50	14	140	140	255	12	40.5
NM4 40-20B																								41
NM4 40-20A																								62
NM4 40-25C						65	40	100	495	180	225	308	125	95	320	250	60	65	14	175	175	300	15	66.5
NM4 40-25B																								78
NM4 40-25A																								78

Référence	Fig.	ISO 228		Dimensions mm																Poids kg						
		DN1	DN2	a	fM	h1	h2	H	m1	m2	n1	n2	n3	b	s	l1	l2	w	g1							
NM4 50-16B	2	65	50	100	470	160	180	288	100	70	265	212	62	50	14	127	141	255	12	39.5						
NM4 50-16A						160	200	288					62			140	153			44.5						
NM4 50-20C						65	50	100	480	160	200	288	100	70	265	212	62	50	14	140	153	310	14	52.5		
NM4 50-20B																	60							310	57	
NM4 50-20A																	68									
NM4 50-25D						65	50	100	490	180	225	308	125	95	320	250	60	65	14	175	175	300	15	78		
NM4 50-25C																								340	330	85.5
NM4 50-25B																								78		
NM4 50-25A																								85.5		

Référence	Fig.	ISO 228		Dimensions mm																Poids kg									
		DN1	DN2	a	fM	h1	h2	H	m1	m2	n1	n2	n3	b	s	l1	l2	w	g1										
NM4 65-16C	2	80	65	100	470	160	200	288	125	95	280	212	62	65	14	150	172	255	15	48									
NM4 65-16B													60							300	54.5								
NM4 65-16A									80	65	100	495	180	225	308	125	95	320	250	60	65	14	155	175	310	15	61		
NM4 65-16S																											340	330	73.5
NM4 65-20B																											78		
NM4 65-20A									80	65	100	540	200	250	360	160	120	360	280	60	80	18	175	190	415	18	97		
NM4 65-25B																											645	415	116
NM4 65-25A									80	65	125	670	225	280	410	160	120	400	315	75	80	18	220	220	415	20	153		
NM4 65-31C																											465	164	
NM4 65-31B																											176		
NM4 65-31A	176																												

Dimensions et poids

Référence	Fig.	ISO 228		Dimensions mm																				Poids kg															
		DN1	DN2	a	fM	h1	h2	H	h4	m1	m2	n1	n2	n3	n5	w1	b	b1	s	s1	l1	l2	w		m4	m5	g1	g2											
NM4 80-16C	2	100	80	125	520	180	225	308	-	125	95	320	250	62	-	-	65	-	14	-	153	181	300	-	-	12	-	56											
NM4 80-16B					545			340						60									320					70											
NM4 80-16A					545			340						60									320					70											
NM4 80-20C					560			340						60									320					70											
NM4 80-20B		100	80	125	560	180	250	340	-	125	95	345	280	60	-	-	65	-	14	-	170	194	340	-	-	15	-	82											
NM4 80-20A					565			360						60									320					91											
NM4 80-25C		100	80	125	565	200	280	360	-	160	120	400	315	60	-	-	80	-	18	-	191	210	335	-	-	20	-	102											
NM4 80-25B					670			385						60									320					124											
NM4 80-25A					670			385						60									320					135											
NM4 80-31C		100	80	125	720	250	315	435	-	160	120	400	315	90	-	-	80	-	18	-	222	234	465	-	-	17	-	181											
NM4 80-31B	3	100	80	125	787	260	315	466	10	160	120	400	315	-	254	20	80	74	18	14	222	234	147	435	395	-	6	248											
NM4 80-31A					787			466						254									20					80	74	18	14	222	234	147	435	395	-	6	269
NMS4 80-315S	4	100	80	125	968	250	315	536	-	160	120	400	315	-	279	25	80	70	18	15	222	234	312	432	382	-	6	-											
NMS4 80-400C					973			566						279									25					80	70	18	15	222	234	312	432	382	-	6	339
NMS4 80-400B					1003			566						279									25					80	70	18	15	222	234	312	432	382	-	6	355
NMS4 80-400A					1051			595						318									25					80	70	18	19	268	269	334	540	455	-	8	413
NMS4 80-400S					1118			618						356									55					103	19	268	269	380	540	460	455	-	8	490	

Référence	Fig.	ISO 228		Dimensions mm																				Poids kg															
		DN1	DN2	a	fM	h1	h2	H	h4	m1	m2	n1	n2	n3	n5	w1	b	b1	s	s1	l1	l2	w		m4	m5	g1	g2											
NM4 100-20C	2	125	100	125	565	200	280	360	-	160	120	360	280	60	-	-	80	-	18	-	180	212	330	-	-	20	-	90											
NM4 100-20B					665			385						60									320					109											
NM4 100-20A					665			385						60									320					109											
NM4 100-25B					125			100						140									760					225	280	410	-	160	120	400	315	75	-	-	80
NM4 100-25A	760	410	75	80		18	205		233	465	-	-	20		-	152																							
NM4 100-315C	3	125	100	140	802	260	315	466	10	160	120	400	315	-	254	20	80	74	18	14	230	250	147	435	395	-	6	261											
NM4 100-315B					802			466						254									20					80	74	18	14	230	250	147	435	395	-	6	280
NMS4 100-315A	4	125	100	140	984	250	315	512	-	160	120	400	315	-	279	25	80	70	18	15	230	250	312	432	382	-	6	308											
NMS4 100-400C					1040			542						279									25					80	70	18	15	230	250	312	432	382	-	6	366
NMS4 100-400B					1040			580						318									25					100	83	22	19	268	280	334	540	455	-	6	419
NMS4 100-400A					1139			605						356									55					103	19	268	280	384	540	460	455	-	6	506	

Référence	Fig.	ISO 228		Dimensions mm																				Poids kg															
		DN1	DN2	a	fM	h1	h2	H	h4	m1	m2	n1	n2	n3	n5	w1	b	b1	s	s1	l1	l2	w		m4	m5	g1	g2											
NM4 125-25E	2	150	125	140	685	250	355	435	-	160	120	400	315	90	-	-	80	-	18	-	235	268	415	-	-	20	-	149											
NM4 125-25D					735																		465					161											
NM4 125-25C					735																		465					173											
NM4 125-250B	3	150	125	140	802	260	355	466	10	160	120	400	315	-	254	20	80	74	18	14	235	268	147	435	395	-	6	243											
NM4 125-250A					802			466						254									20					80	74	18	14	235	268	147	435	395	-	6	261
NMS4 125-315C	4	150	125	140	989	280	355	542	-	200	150	500	400	-	279	25	100	70	18	15	247	278	318	520	435	-	6	331											
NMS4 125-315B					1040			580						318									25					100	83	22	19	268	280	334	540	455	-	6	350
NMS4 125-315A					1139			640						356									55					100	83	22	19	268	280	334	540	455	-	6	409
NMS4 125-400C					1199			640						356									55					100	83	22	19	268	280	334	540	455	-	6	524
NMS4 125-400B					1199			640						356									55					100	83	22	19	268	280	334	540	455	-	6	524
NMS4 125-400A	1307	707	406	45	100	83	24	280	305	409	540	461	-	8	-																								
NMS4 125-400S	1307	707	406	45	100	83	24	280	305	409	540	461	-	8	665																								

Référence	Fig.	ISO 228		Dimensions mm																				Poids kg															
		DN1	DN2	a	fM	h1	h2	H	h4	m1	m2	n1	n2	n3	n5	w1	b	b1	s	s1	l1	l2	w		m4	m5	g1	g2											
NMS4 150-315D	4	200	150	160	1009	280	400	542	-	200	150	550	150	-	279	25	100	70	18	15	260	298	318	520	435	-	6	349											
NMS4 150-315C					1060			580						318									25					100	83	22	19	260	298	334	540	455	-	6	374
NMS4 150-315B					1060			580						318									25					100	83	22	19	260	298	334	540	455	-	6	421
NMS4 150-315A					1159			605						356									55					100	103	22	19	260	298	384	540	460	-	8	501
NMS4 150-400C					1219			640						406									45					100	103	22	19	260	298	409	540	461	-	8	594
NMS4 150-400B					1277			707						406									45					100	103	24	295	328	404	540	461	-	8	681	
NMS4 150-400A					1280			747						457									45					100	103	24	295	328	432	625	535	-	6	845	

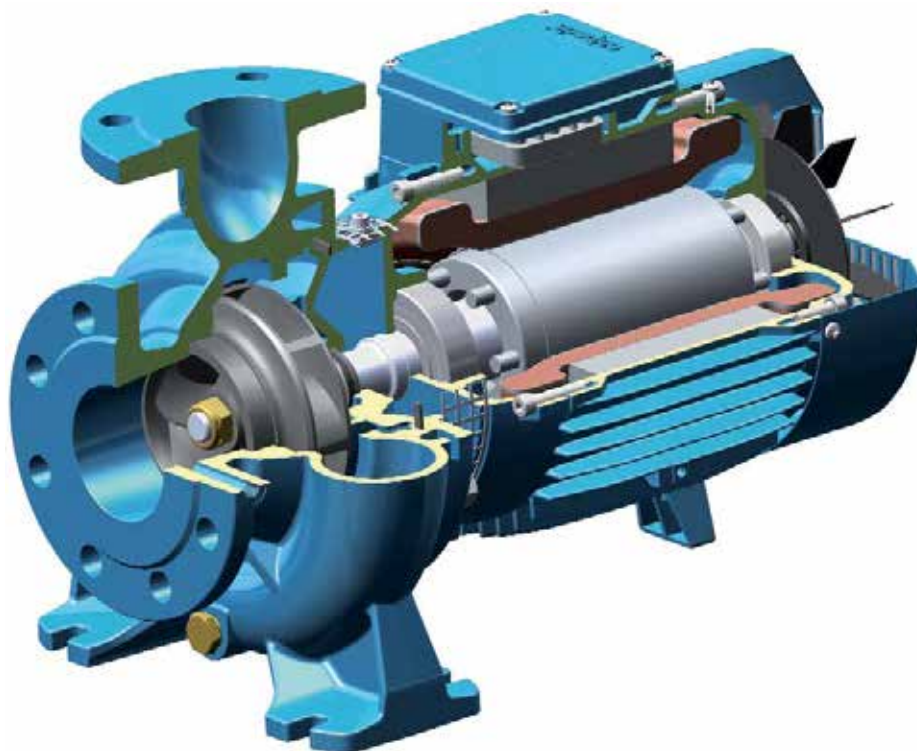

NM4

HYDRAULIQUE D'AVANT-GARDE

Le dessin de la turbine et du corps a été conçu de manière à permettre un très haut rendement tout comme une puissance d'aspiration accrue.

FLEXIBILITÉ D'UTILISATION

Pour les parties en contact avec le liquide pompé il est possible de choisir la fonte ou le bronze ce qui permet l'emploi des pompes pour le pompage de liquides divers.

DESSIN COMPACTE

La structure compacte permet l'installation dans des espaces réduits.

DESSIN EXCLUSIF

Pour la sécurité des utilisateurs un dispositif de protection de nouveau dessin empêche le contact avec les parties rotatives de la pompe et permet un accès aisé à la garniture mécanique.

FIABILITÉ

La dimensions des roulements et de l'arbre a été étudiée pour garantir la réduction de sa sollicitations mécaniques pour une haute fiabilité du produit dans toutes conditions d'utilisation.

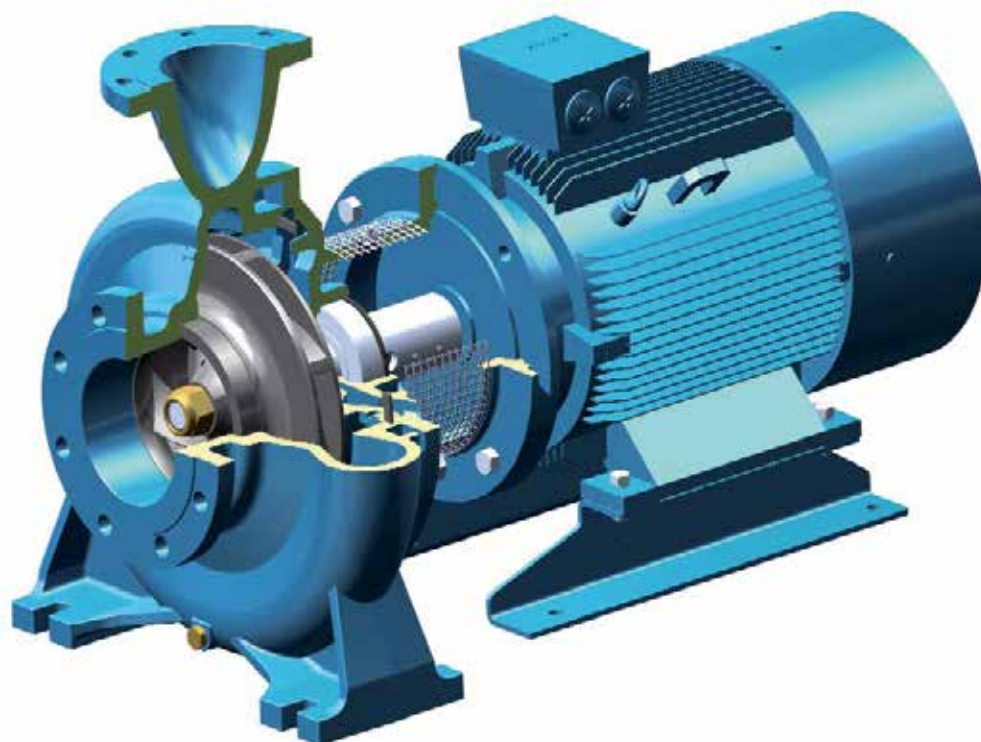

NMS4

HYDRAULIQUE D'AVANT-GARDE

Le dessin de la turbine et du corps a été conçu de manière à permettre un très haut rendement tout comme une puissance d'aspiration accrue.

FIABILITÉ D'UTILISATION

Pour les parties en contact avec le liquide pompé il est possible de choisir la fonte ou le bronze ce qui permet l'emploi des pompes pour le pompage de liquides divers. Le couvercle séparé du raccordement

permet un entretien aisé.

RACCORDEMENTS DE NOUVEAU DESSIN

Les lanternes de raccordement sont équipées d'un coussinet anti-choque (?) à la partie hydraulique qui assure l'absence de charges supplémentaires au niveau des roulements moteur. La dimension des brides permet le montage sur tout moteur standard de construction B35.

DESSIN EXCLUSIF

Pour la sécurité des utilisateurs un dispositif de protection de nouveau dessin empêche le contact avec les parties rotatives de la pompe et permet un accès aisé à la garniture mécanique.

ENTRETIEN AISÉ DU MOTEUR

Le coussinet anti-choque à la partie hydraulique permet le démontage aisé du moteur et en facilite l'entretien sans risques pour la partie hydraulique.

**FABRICANT
DEPUIS 1959**



Italie

Calpeda S.p.A.
Via Roggia di Mezzo 39,
36050 Montorso Vicentino - Vicenza
Tel. +39 - 0444 476 476
Fax +39 - 0444 476 477

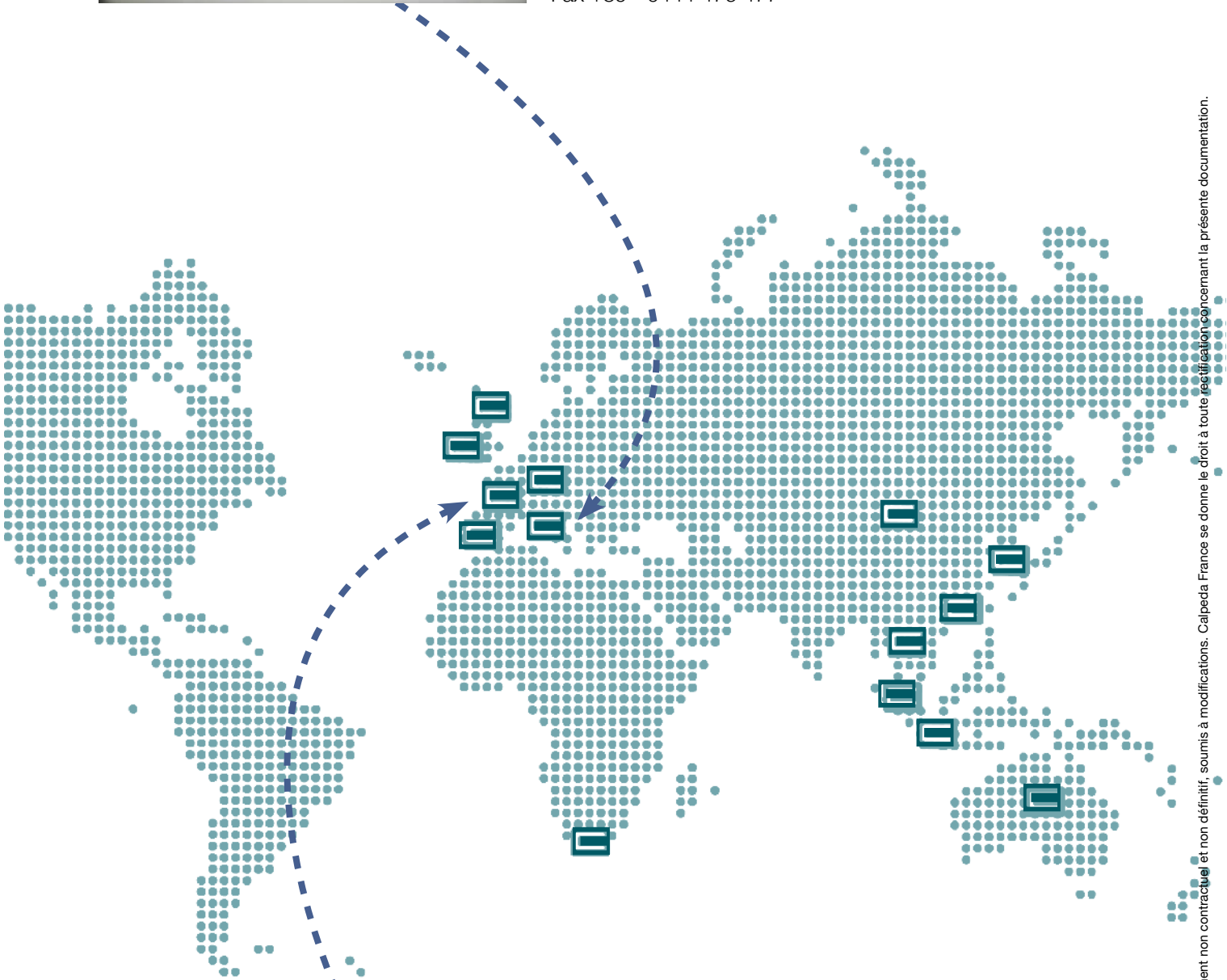

**À VOTRE SERVICE
DEPUIS 29 ANS**



France

Calpeda Pompes
19, rue de la communauté - ZA La Forêt
44140 LE BIGNON
Tél. 02 40 03 13 30 - Fax 02 40 03 16 70
e.mail : info@calpeda.fr - Site : www.calpeda.fr



water passion